

INSTALLATION INSTRUCTIONS

TSOL 20 N BLU



CONFORMITY

Solar collectors conform to EN 12975 standard

and to Solar Keymark certification standard.

RANGE

MODEL	CODE
TSOL 20 N BLU	20005823
Kit of 7 collectors TSOL 20 N BLU	20005825

Dear Customer,

*We thank you for playing your part in saving the environment and for choosing a top quality solar collector. You have purchased a modern product that is easy to install and use, and is designed to give you dependable and safe energy savings for many years to come. You can keep your new solar collector in peak condition by having it serviced regularly by an authorised **THERMITAL** Technical Assistance Centre.*

This instruction manual contains important instructions and precautions that must be observed to ensure the trouble-free installation and efficient functioning of your solar collector.

Please accept our thanks and our congratulations on your choice of product.

Riello S.p.A.

CONTENTS

GENERAL

General safety information and precautions	page 5
Description of the solar collector	“ 6
Identification	“ 6
Design	“ 7
Technical specifications	“ 8
Accessories	“ 8
Water circuit	“ 9
Location of probes	“ 10

FOR THE INSTALLER

Unpacking the collector	page 11
Dimensions and weight	“ 12
Handling the collector	“ 12
Installation	“ 13
Filling the circuit	“ 14
Checks	“ 15

The following symbols are used in this manual:













CAUTION! = Indicates actions that require caution and adequate preparation.



STOP! = Identifies actions that your MUST NOT do.

This manual, Code 20007790 - Rev. 0 (10/08) is made up of 16 pages.

GENERAL SAFETY INFORMATION AND PRECAUTIONS

-  As soon as you open the packaging, check immediately that the contents are all present and undamaged. Contact the reseller from whom you purchased the solar collector if you notice any problems.
-  This solar collector must be used only for the proper purpose for which it is designed and made. The manufacturer declines all responsibility, contractual or other, for damage to property or injury to persons or animals caused by improper installation, adjustment, maintenance or use.
-  The solar collector must be serviced every two years.
-  Work near uncovered and live electrical wires, with which it is possible to come into contact, is only permitted under the following conditions:
- Wires must be free from voltage for the entire duration of the work.
 - Parts remaining live must be covered or accidental contact prevented.
 - The following minimum safety distances must be respected:
 - 1 m for voltages of up to 1000 Volts
 - 3 m for voltages from 1000 to 11000 Volts
 - 4 m for voltages from 11000 to 22000 Volts
 - 5 m for voltages from 22000 to 38000 Volts
 - over 5 m if the voltage is not known.
- Contact with open, live electrical wires may lead to electrocution and may even be fatal.
-  Always wear safety goggles when drilling. Always wear safety shoes, cut-proof protective gloves and a safety helmet when performing installation work.
-  Before beginning installation work on roofs, install the necessary fall prevention and fall arrest devices and ensure that all applicable safety standards are applied.
Use only tools and materials that conform to the safety standards that are applicable in the place of work.
-  Only wear overalls that have a safety harness (with a suitable safety or fall-arrest belt, ropes or slings, fall dampers or dissipaters). In the absence of adequate fall prevention and security devices, failure to use a proper safety harness may lead to falls from great heights with serious or even fatal consequences.
-  The use of ladders leaned against walls can lead to serious falls if the ladder slips, slides or falls. When using ladders, always ensure that they are stable, and that suitable ladder stops are present. If possible secure the ladder with hooks. Make sure that there are no live electrical wires near the ladder.
-  Especially when installing the solar collector as part of a domestic hot water system, follow the orientation and angle of the roof to ensure that the collector blends in with the architecture of the building.
-  This instruction manual is an integral part of the solar collector. It must be kept safe and must ALWAYS accompany the solar collector, even if it is sold to another owner or transferred to another user or to another installation. If you damage or lose this manual, order a replacement immediately from your local Technical Assistance Centre.

DESCRIPTION OF THE SOLAR COLLECTOR

These panel type solar collectors have four water fittings and consist of an aluminium frame to which a single-piece copper absorber plate is secured. This has a highly selective finish obtained by a special vacuum treatment called "TiNOX" that guarantees excellent collector performance. The absorber plate is ultrasonically welded to 10 copper pipes through which the heat transfer fluid flows. The two main pipe connection manifolds are also in copper. The heat transfer fluid runs through the 10 parallel pipes of the absorber plate.

Each panel is protected by solar, hail-proof, tempered glass with low iron oxide content and a high energy transmission factor. The bottom of the tray is lined with 3 cm of rock wool insulation. The temperature probe is installed in a special copper socket.



These solar collectors are easy to install. Provided they are properly installed, they provide reliable, long lasting and extremely efficient service.

IDENTIFICATION

The solar collectors are identified by two plates:

- Data plate

This lists the technical specifications and performance of the product.

CODE : 0500201	
S/N :	
DESCRIPTION : CP20TS	MADE IN ITALY by Riello S.p.A.
PLATE SOLAR COLLECTOR	
DIMENSIONS : 1856X1086X90 mm	MAXIMUM OPERATING PRESSURE : 10 bars
GROSS AREA : 2,02m ²	MAXIMUM TEMPERATURE : 210 °C
EXPOSED AREA : 1,81 m ²	LIQUID CONTENT : 1,35 l
ABSORBER AREA : 1,77 m ²	MAX GLYCOL CONCENTRATION : 50 %
EMPTY WEIGHT : 32 kg	HEAT TRANSFER FLUID : WATER + PROPYLENE GLYCOL
UP TO MAX 6 COLLECTORS CAN BE CONNECTED	

- Serial number plate

This bears the collector's code number, model and serial number.

	
Via Mussa, 20 Z.I. 35017 Piombino Dese (PD) - Italia	
Code	Serial Number
Model	

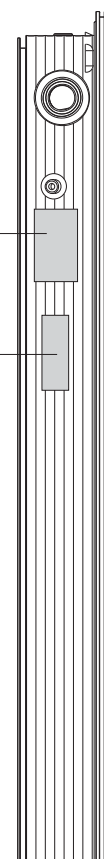

 If these plates or any other means of clearly identifying the product are defaced, removed or lost, proper installation and servicing may be rendered difficult.

DESIGN

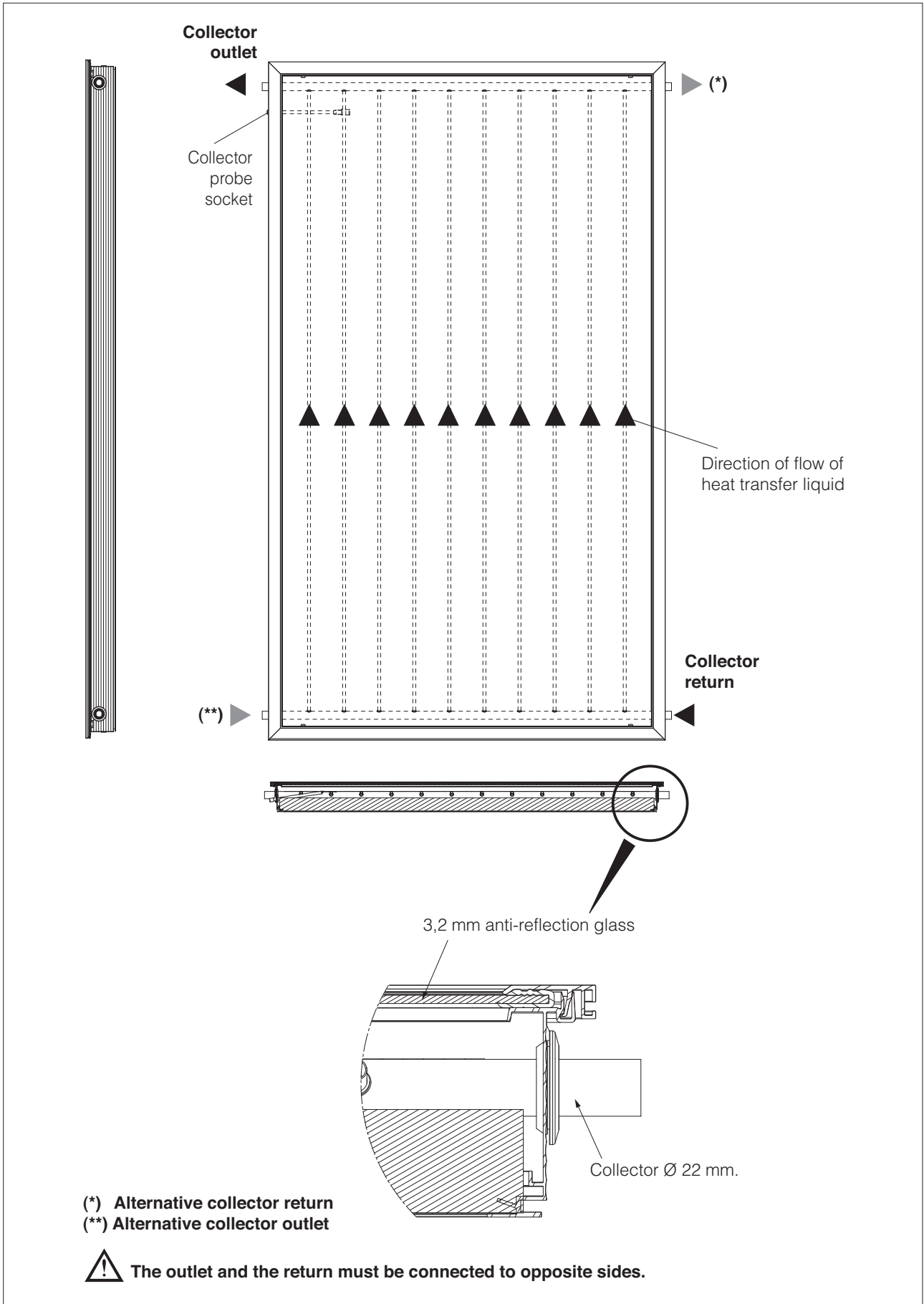

TECHNICAL SPECIFICATIONS

DESCRIPTION		
Total area	2,02	m ²
Exposed area	1,81	m ²
Effective absorption area	1,77	m ²
Connections (copper tube)	4 x Ø22	mm
Empty weight	32	kg
Liquid content	1,35	l
Recommended flow rate per m ² of panel	30	l/h
Glass type - thickness	safety glass with anti-reflective surface - 3,2 mm	
Absorption (α)	95	%
Emissions (ϵ)	5	%
Maximum permitted pressure	10	bar
Maximum temperature	210	°C
Maximum number of collectors connectable in series	6	n°

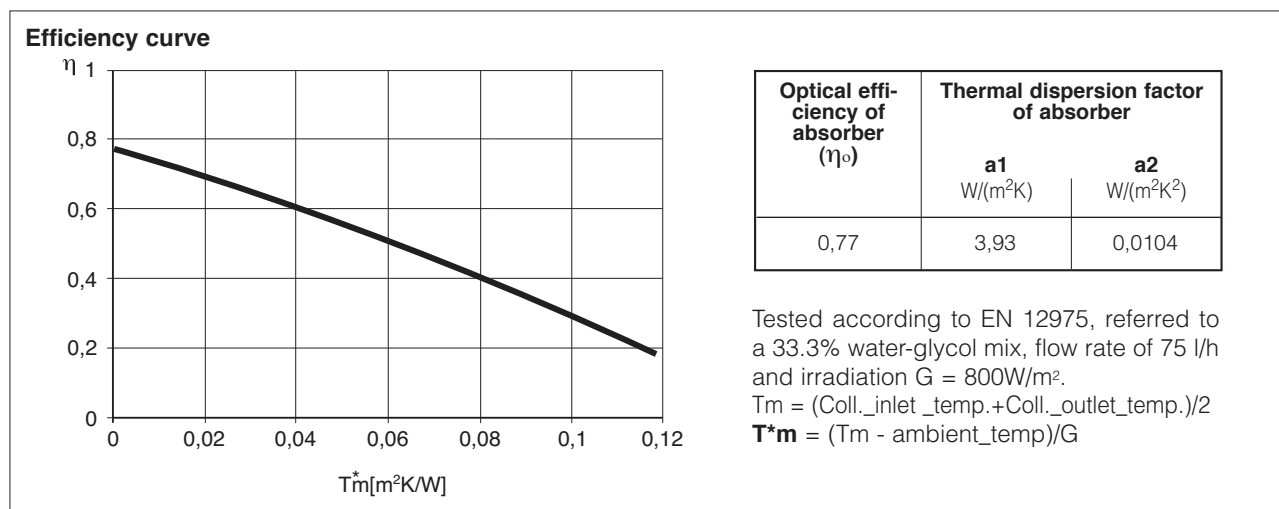

Diameter of connection pipes for a specific flow rate of 30 lt/m²h

Total surface area (m ²)	ca 5	ca 7,5	ca 12,5
Diameter of copper pipe (mm)	10-12	15	18
Diameter of steel pipe	DN16		DN20

WIND AND SNOW LOADS ON COLLECTORS

Installation height above ground	Wind speed	Mass in kg to secure collector against lifting by wind		Load on roof from wind, snow, and collector weight	
		At angle of 45°	At angle of 20°	At angle of 45°	At angle of 20°
0 - 8 m	100 km/h	80 kg	40 kg	320 kg	345 kg
8 - 20 m	130 km/h	180 kg	90 kg	470 kg	430 kg
20 - 100 m	150 km/h	280 kg	150 kg	624 kg	525 kg

ACCESSORIES

The following accessories are available, to be ordered separately.

ACCESSORY	CODE
Threaded straight union kit for Ø 22 mm pipes	20007285
Threaded end union kit for Ø 22 mm pipes	20007286
Threaded curve union kit for Ø 22 mm pipes	20007278
Manual bleed valve	4383056
Thermostatic mixer valve	4383076
Glycol anti-freeze (5 kg)	4383085
Glycol anti-freeze (10 kg)	4383059

WATER CIRCUIT

The diagram below illustrates the water connections between solar collectors and a storage heater.

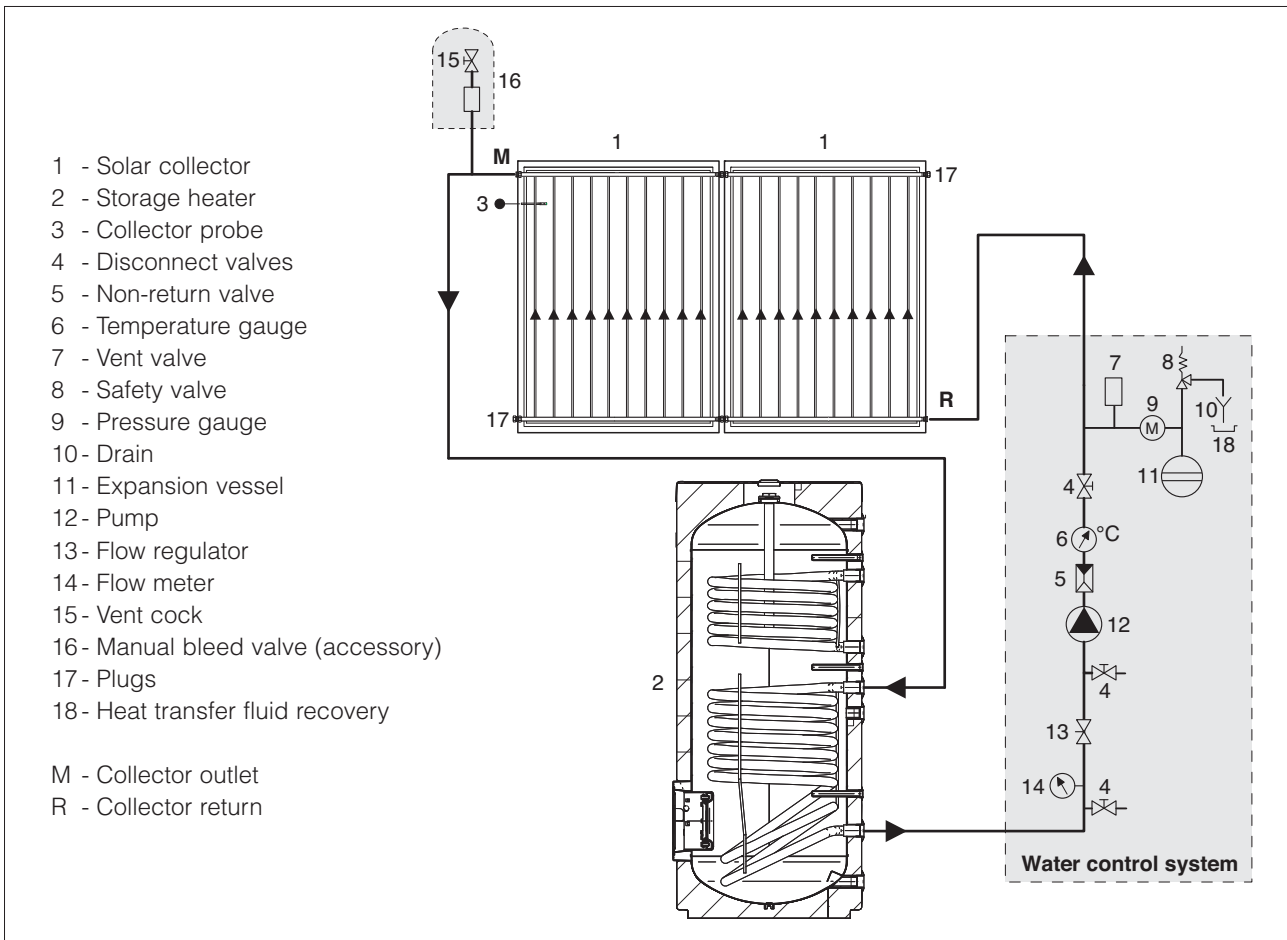

⚠ Connect no more than 6 collectors in series.

⚠ If copper pipes are used, joints must be hot brazed.

⚠ We recommend the use of stainless steel pipes specially made for solar collectors for the outlet, return and probe pipes. The probe cable should be of the shielded type.

⚠ Do not use plastic or multistrata pipes. Operating temperature can exceed 180°C.

⚠ Pipe lagging must be able to resist high temperatures (180°C).

Pressure drop in solar collectors (*)

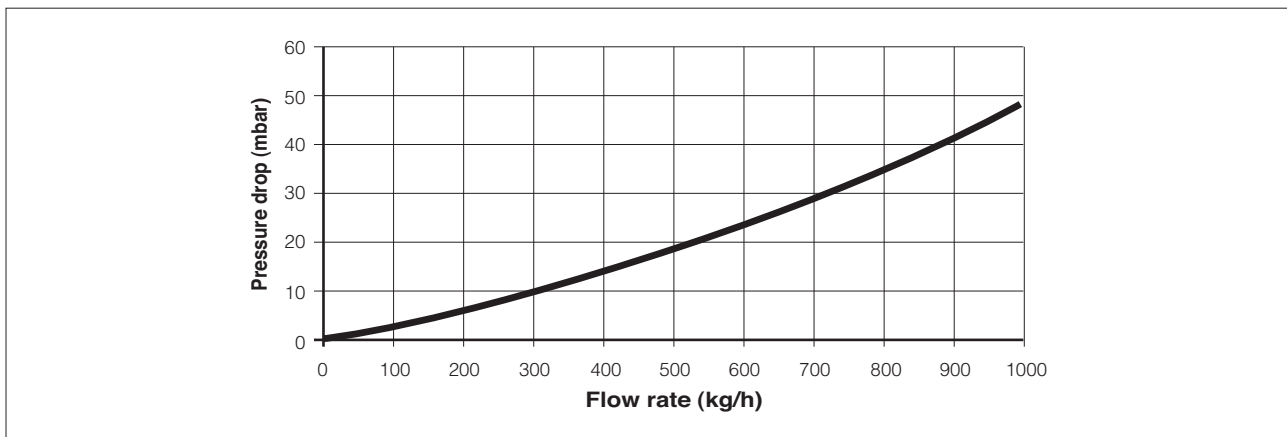

(*) With antifreeze-water mix of 33,3% / 67,7% and heat transfer medium temperature = 20°C.

LOCATION OF PROBES

The temperature sensor must be installed in the nearest socket to the collector outlet. Make sure that the sensor makes good contact with the socket. Materials (sensor, cables, seals and insulation) used to install the temperature sensor must be able to withstand high temperatures (up to 250°C).

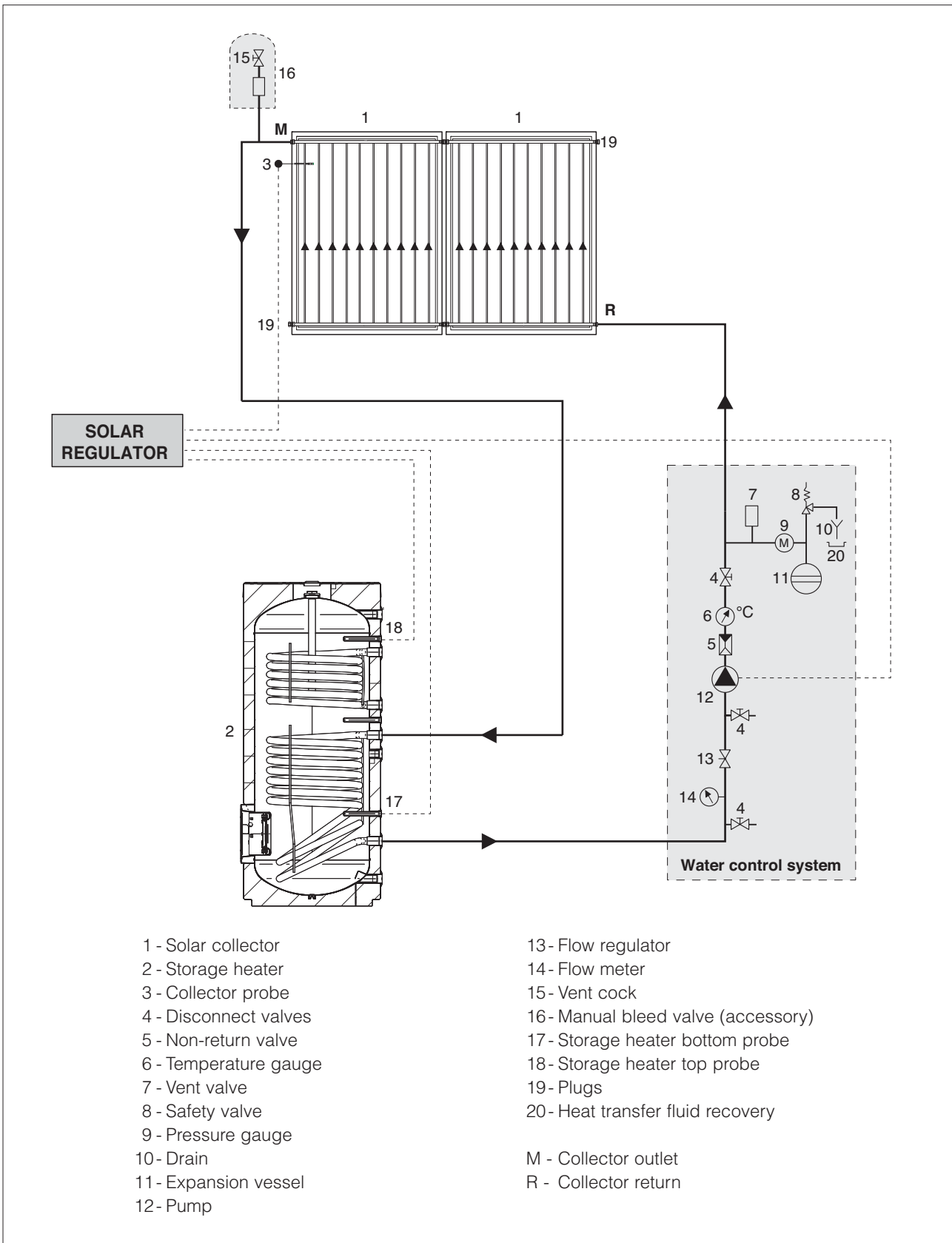

UNPACKING THE COLLECTOR

The solar collectors are packed in various ways depending on the number of units supplied.

A - Individually packaged collectors

Pallet contents:

- collector
- Documentation envelope containing:
 - certificate of warranty and label with bar code.

Case A

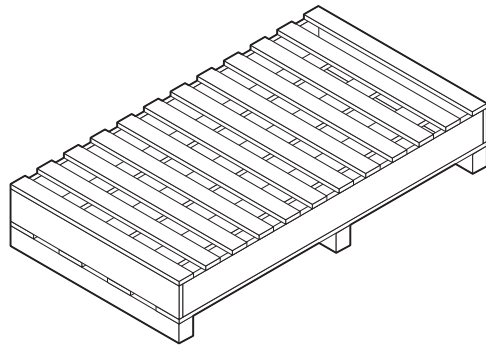

B - Packages of 7 collectors

Pallet contents:

- 7 collectors
- Documentation envelope containing:
 - certificate of warranty and label with bar code.

 Take care not to lose the flat seal strapped to the fittings of the solar collector.

 The instruction manual is an integral part of the solar collector. Once located, read it thoroughly and keep it safe.

Case B

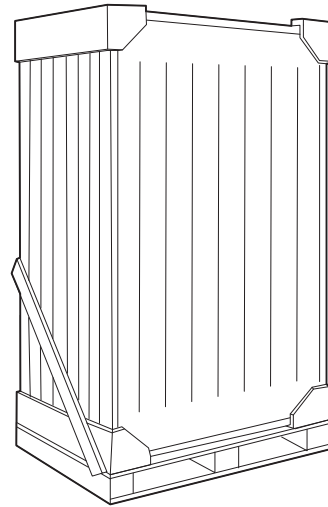

DIMENSIONS AND WEIGHT

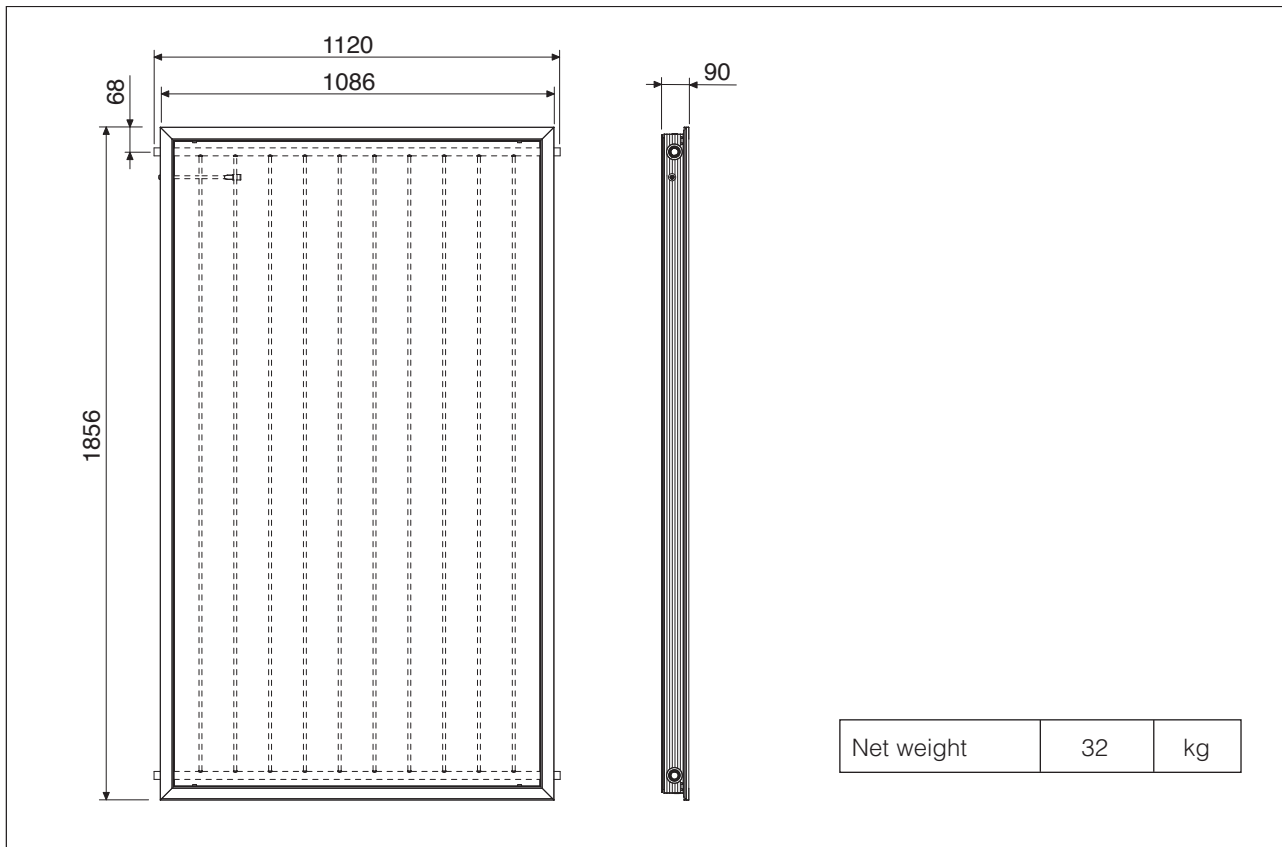

HANDLING THE COLLECTOR

Once you have removed the outer packaging, proceed as follows to unpack and handle the solar collector:

- Remove the PVC wrapping to free the solar collector from the pallet.
- Tilt the solar collector slightly and grip it at the four points shown (A) to lift it.
- Use a hoist or other suitable lifting equipment to hoist the solar collector on to the roof.

⚠ Wear suitable personal protective equipment and use suitable safety devices.

⊘ Do not dispose of the packaging material into the environment where it can become a potential hazard. Dispose of the packaging material in compliance with applicable legislation.

⊘ Do not lift the collector by means of its outlet or return pipes.

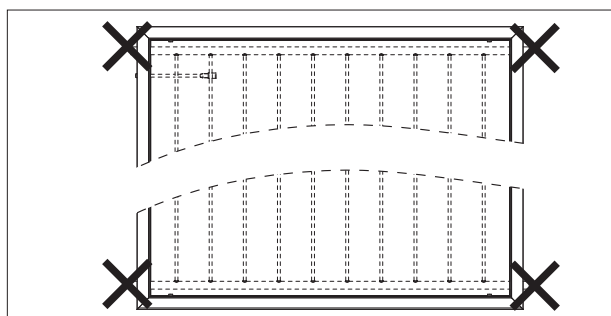
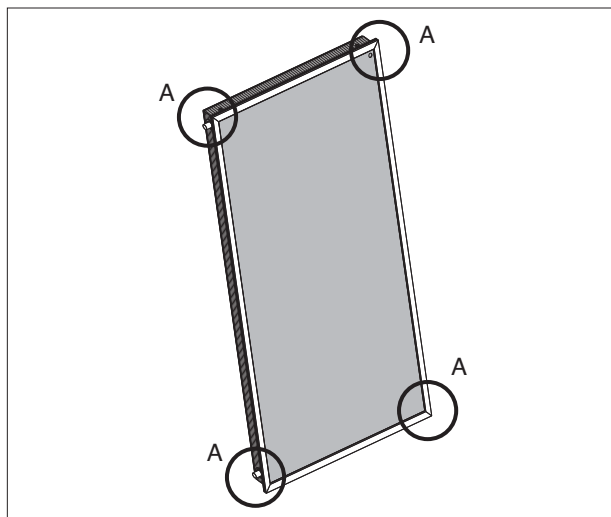

GENERAL INSTRUCTIONS

Assembly

The solar collector must be fitted by specialist personnel. Use only the assembly material supplied with the solar collector. The supporting framework and all masonry or brickwork fixing points must be checked by a person expert in static loading, and must be suitable for the nature of the installation site.

Static load

The solar collector must only be installed on roofs or frames that are strong enough to support its weight. The strength of the roof or frame must be verified on site by a person expert in static loading before the solar collector is installed. During this process, it is important to verify the suitability of the supporting frame to hold the screw fasteners that fix the solar collector in place. An expert in static loading must verify that the entire frame complies with relevant standards, especially in areas liable to snow and areas exposed to high winds. Conditions (gusts of wind, formation of wind vortices, etc.) at the point where the solar collector is to be installed must be carefully considered since these can increase the loads on the supporting structure.

Lightning protection

The metal piping of the solar heating circuit must be connected to the main potential compensation bar by a (yellow-green) copper wire (H07 V-U or R) of at least 16 mm². If a lightning conductor system is already installed, the solar collectors may be connected to the existing system. Alternatively, the solar collector piping may be connected to ground via a ground wire sunk into the earth. Ground wires must be sunk outside the house. The ground wire must be connected to the potential compensation bar through a wire of the same diameter.

Water connections

If flexible pipes are not used to connect the solar collectors, the piping must be fitted with expansion joints (U-type expansion joints, flexible hoses) to absorb thermal expansion. Provided adequate expansion joints are used, up to 6 solar collectors may be connected in series. Make sure that the seal rings are correctly positioned in their seats. When tightening a fitting with a pipe wrench or spanner, always hold the opposite fitting steady with a second tool to avoid damaging the absorber.

 All pipes in the water circuit must be insulated in conformity to relevant standards. Lagging and insulation must be protected against damage by the weather and birds and animals.

Angle of collectors / General

Solar collectors are designed to be installed at angles of between 15° (minimum) and 75° (maximum). Make sure that the bleed and vent valves of the collec-

tors remain open while the collectors are being installed. Take care to protect all fittings, connections, bleed and vent valves against dirt and dust etc.

In installations which serve primarily to produce domestic hot water in the summer, install the collectors facing from east to west at an angle of between 20 and 60°. The ideal orientation is southwards, at an angle equal to the latitude of the location minus 10°.

If the system sustains the greatest thermal load in the winter (as in systems that combine domestic hot water production with central heating), install the collectors facing south (or south-east or south-west) at an angle greater than 35°. The ideal orientation is southwards, at an angle equal to the latitude of the location plus 10°.

Flushing and filling

For safety reasons, only fill the system when the sun is not shining. In areas liable to frost, fill the circuit with a 40% glycol solution for solar panels.

 The anti-freeze solution must be mixed with water prior to filling the system.

 Take care if you flush the system out, because any trapped water may freeze if the circuit is not filled immediately with anti-freeze.

Bleeding

Bleed the circuit:

- On start-up (after initial filling) (see the figure on page 10).
- Whenever necessary, as in the event of system malfunctioning.

Make quite sure that all air has been bled out of the system.

 Risk of burns from hot fluid inside the collectors!

 Only open the vent valve if the temperature of the fluid in the circuit is below 60°C.

Make sure that the collectors are not hot before you start bleeding the circuit. Always cover the solar collectors before bleeding the circuit. Always perform bleeding in the morning.

Checking the heat transfer liquid

Check the anti-freeze effect and the pH level of the heat transfer liquid every 2 years.

- Use an instrument like a refractometer or densimeter to check the anti-freeze effect (which must have a nominal protection value of approx. -30°C). If the protection threshold is higher than -26°C, replace the mix, or add anti-freeze as required.

- Use litmus paper to check the pH (nominal value approx. 7.5). If the measured value is below 7, change the mix.

FILLING THE CIRCUIT

Perform the following steps before starting up the system.

1 - FLUSHING AND SEAL TESTING THE SYSTEM

If copper piping has been used and joints have been hot brazed, flush out the system to remove any brazing residues. Seal test the system after you have flushed it out.

⚠ Fill the solar collector with glycol/water mix immediately after flushing it out, because flushing water may remain trapped in the circuit (with a consequent risk of freezing).

2 - PREMIXING WATER + GLYCOL

Glycol anti-freeze is supplied separately in standard volumes and must be premixed with water in a suitable container before being used to fill the system. For example, a mix of 40% glycol and 60% water provides anti-freeze protection down to a temperature of -21°C.

⚠ The propylene glycol supplied is specially formulated for solar collector applications and remains fully efficient throughout the -32 to +180°C temperature range. It is also non-toxic, biodegradable and biocompatible.

⚠ Do NOT part fill the circuit with pure glycol then add water later.

Anti-freeze	Temperature	Density
50%	-32°C	1,045 kg/dm ³
40%	-21°C	1,037 kg/dm ³
30%	-13°C	1,029 kg/dm ³

⚠ Do not use automatic or manual filling systems.

⚠ If the water supply is highly chlorinated, use distilled water to prepare the glycol/water mix.

3 - FILLING

- 1 - Open the non-return valve (A).
- 2 - Open the air vent at the highest point in the system (see figure alongside) and keep it open throughout the filling operation.
- 3 - Open the vent valve (7).
- 4 - Pump the heat transfer fluid around the circuit with an external filling pump until all air bubbles have been eliminated. Close the manual bleed valve.
- 5 - Temporarily raise the pressure in the system to 4 bar.
- 6 - Start up the system for about 20 minutes.
- 7 - Bleed the system again from step 2 until all the air has been removed.
- 8 - Set the pressure in the system to 3 bar.
- 9 - Close the non-return valve (A) and any open vent valves to prevent the heat transfer fluid from evaporating.

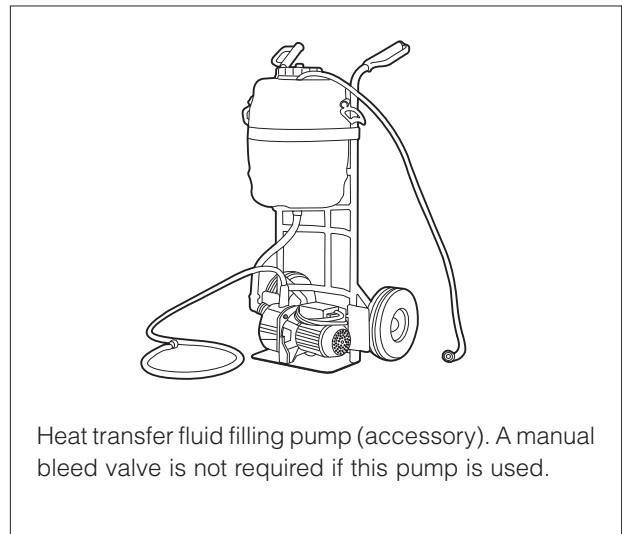

Heat transfer fluid filling pump (accessory). A manual bleed valve is not required if this pump is used.

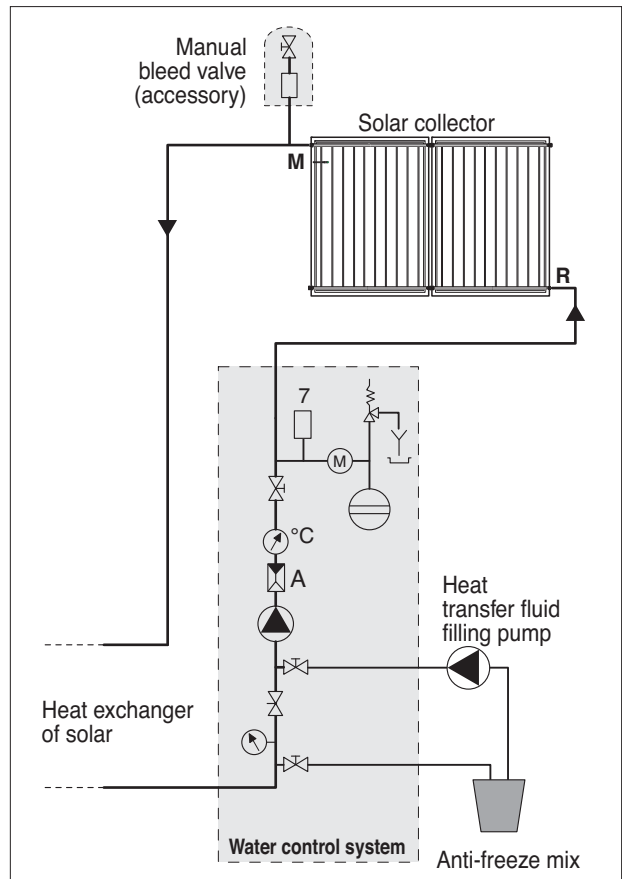

⚠ Do not fill the system in bright, sunny conditions or if the collectors are hot.

⚠ Make sure that you have bled all the air out of the system, using the water control system vent too.

CHECKS

On completion of the installation, perform the checks listed in the table below.

DESCRIPTION	OK
Collector circuit	
Cold pressure 3 bar	
Collector circuit seal test	
Safety valve check	
Anti-freeze checked to - ____ °C	
pH of heat transfer fluid = ____	
Collector circuit bled	
Flow rate of 30l/h per m ² checked	
Non-return valve functioning	

DESCRIPTION	OK
Solar collectors	
Visual check of collectors	
Collectors cleaned if necessary	
Visual check of collector fixing points	
Visual check of roof impermeability	
Visual check of insulation/lagging	



Via Mussa, 20 Z.I. - 35017 Piombino Dese (PD) - Italia
Tel. 049.9323911 - Fax 049.9323972 - www.thermital.com - email: info@thermital.it

The manufacturer strives to continuously improve all products.
Appearance, dimensions, technical specifications, standard equipment
and accessories are therefore liable to modification without notice.